

A-A (1/2)

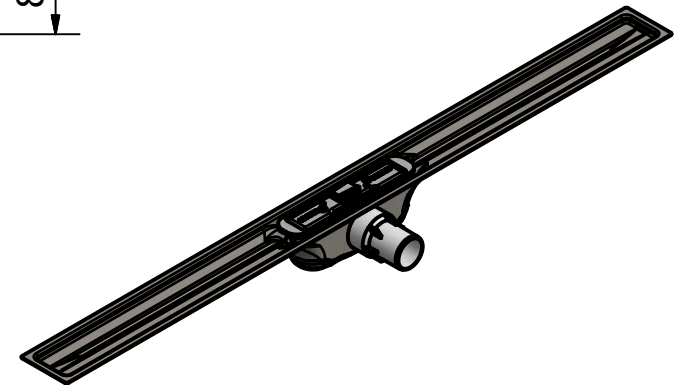
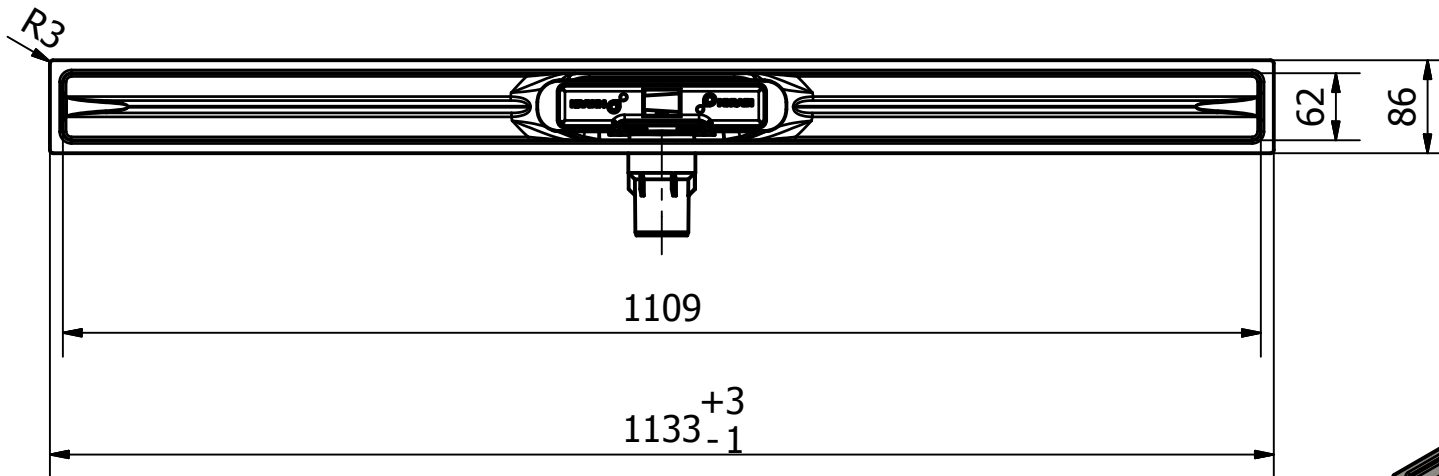
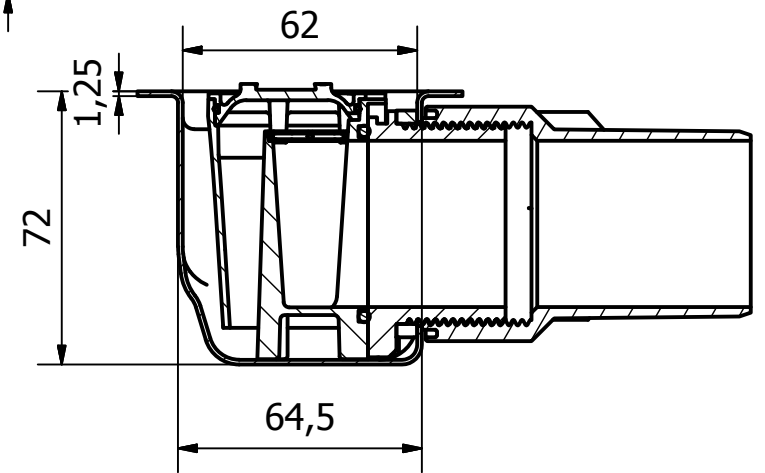

www.i-drain.com
 Ambachtsweg 14
 3890 Gingelom
 Belgium
 T +32 (0) 11 68 96 68
 F +32 (0) 11 68 50 86

PROJECT:IP5M11001X1	Tol: ISO-2768-C	Datum: 2/03/2018	A4
Omschrijving:IP5M11001X1	Tekenaar: Jonas	Materiaal:	Schaal: 1/6
Goedkeuring:	Tekening:IP5M11001X1.dwg		Rev.1